



Paulmann

Safety Instructions

1, 2, 3, 4, 5, 6, 7, 10, 12, 13, 14, 15, 16, 19, 20, 21, 22, 24, 28, 33, 34



31.08.2021



A++ - A

01.09.2021



G



www.paulmann.com/symbols

Paulmann Licht GmbH
Quezinger Feld 2
31832 Springe
Germany



www.paulmann.com

Art.-Nr.: 933.76
933.77_933.78
933.79_933.80
933.81_933.82
933.83_933.84
933.85

(+MA326) PGE 06/22



933.76_933.78
933.80_933.82
933.84



1x

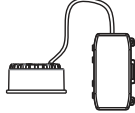

1x



2x

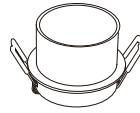

3x

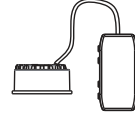

3x



6x

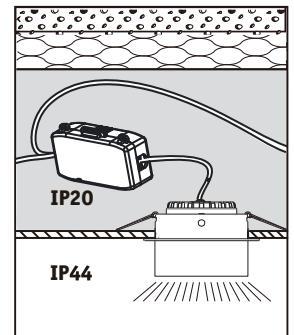
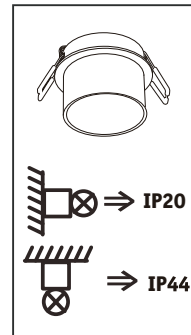
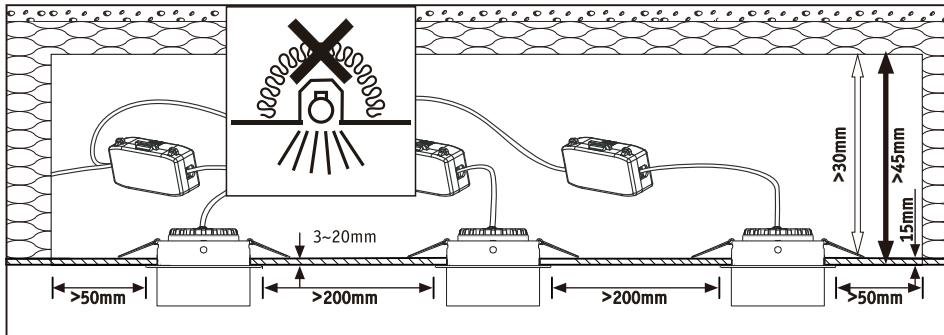
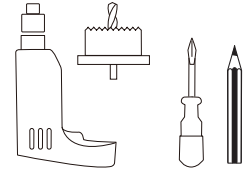

A Safety Instructions Nr. 1, 4, 5, 7 off

⚠️ 👁️ 🔧
⌀ 62mm

B

C

a. ⌀8-12mm 7mm 14mm

b. ⚠️ Nr. 3, 4, 5, 6

D

E

F

on

100% 50% 25%

1x 2x 3x

on - off - on

1s ≤ T ≤ 5s

⚠️ 👁️

⚠️ X

OK

⚠️ ✓

470 lm
6W
230 V
warm white
2700K
CRI/Ra ≥ 80
ON OFF ⏸️ ≥50.000
≈30x 1.000h
Lumen LMN <1 s
6 kWh/1000h
390093690

